

# SunBURST 8

## Colour Changing

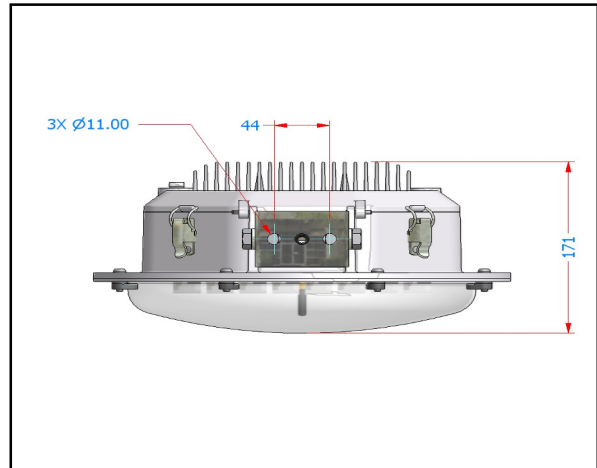

**INTELLIGENT ENERGY SAVING SOLUTIONS WITH THE SUNBURST 8.** The SunBURST LED light is capable of providing up to 95% cost savings compared with traditional lighting solutions.

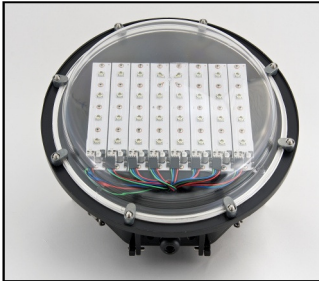

**FEATURES: SUNRISE TO SUNSET COLOUR CHANGE TRANSITIONS PLUS OPTIONS FOR LUNAR AND SOLAR YEARLY CYCLING.**



### ◆ Photovoltaic PV Sensor

Automatically adjusts the LED light output in response to ambient light levels. LED power output to ambient light level matrix is fully programmable.

### ◆ Automatic LED Temperature Control

Will automatically reduce if the LED PN junction exceeds the set operating temperature (ensures maximum lamp life).

### ◆ PIR Movement Sensors

Used to trigger a single light or a group of lights in common or multiple areas. Ideal for storage facilities.

Wirelessly no need for cabling between lights.

### ◆ Lighting Schedules

A range of 32 schedules can be programmed facilitating various power saving modes. Schedule 24/7 on/off dimming etc.

### ◆ Radio Control

Full wireless remote control of all parameters is possible from a control PC via a radio interface. No need for cables or access equipment. No cost for data.

### ◆ Advanced Control

Includes fault reporting, 1-100% dimming from any output power, timer and system diagnostics, alarms, history, ramping power from 0 sec-2 hours, security etc.

### ◆ Colour Rendering

Our standard package has  $Ra \geq 75$ .

*Provides Option for Lunar & Solar cycling for the light*

### ◆ Settings

All settings are programmable allowing for 100% light customisation.

### ◆ Rotation LED Module & variable optics

Various optics can be applied and used in conjunction with the rotational LED modules on the light to maximise the light output potentially allowing for the light to be dimmed further to save power.

**BRACKETS: Choose from our following brackets:**

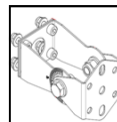

#### Type 1 Bracket

Rotating wall/ ceiling mount

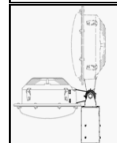

#### Type 6 Bracket-76mm mount

Type 10 Bracket-62mm mount

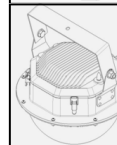

#### Type 15 Bracket

Hanging

### APPLICATIONS:-

Aquarium Lighting  
Architectural Lighting

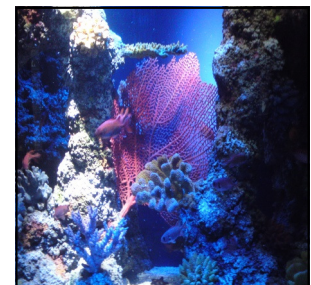

### Replacing 400w Metal Halides



# SunBURST 8

## Colour Changing



### SPECIFICATIONS:

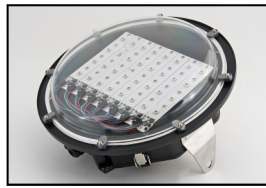

◆ PRODUCT CODE:	SUNBURST 8 (80W) SB8 Available in AC Power (A) or DC Power (D) options
◆ SUPPLY VOLTAGE	20 – 28VDC, 90 – 264VAC & 127 – 396VDC PFC—0.90 @ 240VAC—0.98 @ 115VAC
◆ POWER RATING	Programmable and variable range between 8 – 80 Watts 8—70 Watts (INDOOR) Circuit Power - 88watts @ max
◆ LUMEN LEVEL	Average actual measured lumens 6,240
◆ OPERATING TEMPERATURE	- 35°C to + 60°C Ambient (with cold start protection using ramp set)
◆ CIRCUITRY OPERATING TEMPERATURE	LEDs – 150°C Maximum Tj (Junction Temperature) Controller board circuitry – 105°C Maximum Typical operating conditions at full power, Tj = 80°C
◆ HUMIDITY	0 – 99%
◆ INGRESS CLASSIFICATION	IP66
◆ BODY MATERIAL	High Grade Cast Aluminium, Powder Coated
◆ LENS MATERIAL	Polycarbonate graded at ISO 178
◆ LENS LIGHT TRANSMISSION	Luminous Transmittance 88% +
◆ LIGHT COOLING	Convection & Software Temperature Controlled
◆ COLOUR APPEARANCE & RENDERING	5,300—6,350 Kelvins 8,000— 10,000 Kelvins RGB
◆ LUMINAIRE LIFETIME	Approx. 77,000 hours when operated at a Tj of below 80°C to L70 standard or 57,000 hours to LM80 standard
◆ PHOTOCELL & MOVEMENT SENSOR	PV sensor inbuilt providing a variable light output depending on ambient light level. Programmable settings can be used in conjunction with PIR sensor
◆ COMPLIANCE	CE, RoHS, BS EN 60598-2-3:2003, BS EN 60598-1:2004 TUV (UL), EMC, FCC
◆ FINISH	Powder coated finish in grey RAL 7047 or black upon request
◆ DIMENSIONS-WEIGHT	34cm (L) X 34cm(W) X 19cm (H)- Weight: 6.6kg
◆ MOUNTING	Ceiling, Hanging, Rotational, Pole Mounted
◆ PRODUCTION	Made in United Kingdom
◆ OPTIC CHOICES	Area, Wide, Medium, Spot, Square, Asymmetric or any combination.

### OPTICAL PATTERN:

#### No Optics

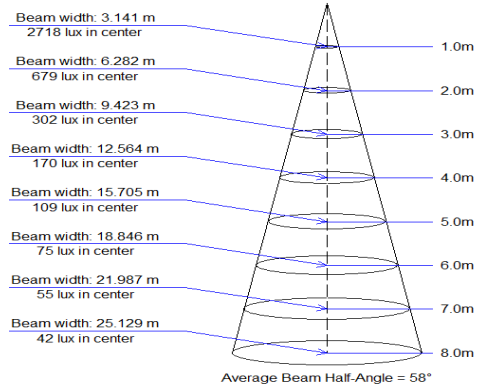

#### Wide Optics

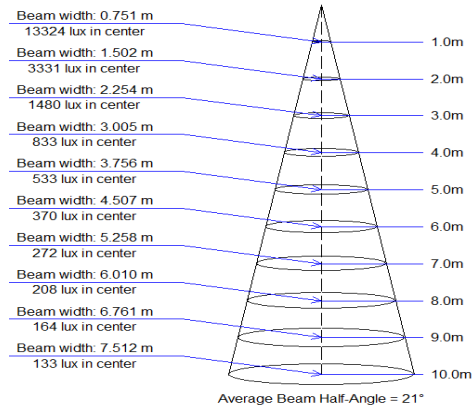

#### Medium Optics

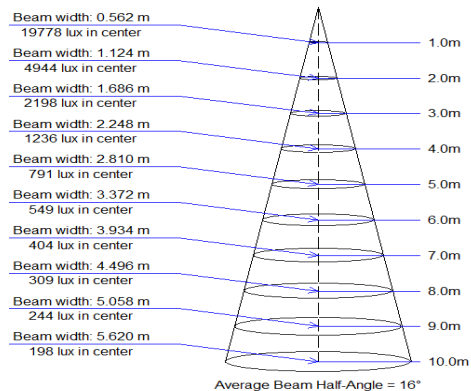

#### Spot Optics

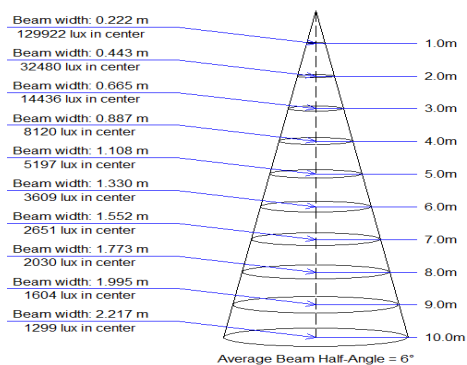

LOW ENERGY DESIGNS LTD  
UNIT 11/13 BRIDGE STREET  
STURMINSTER MARSHALL  
DORSET BH21 4DB  
UNITED KINGDOM

PLEASE CONTACT US AND LET US HELP YOU TO CUT COSTS AND REDUCE YOUR CARBON FOOTPRINT.  
TEL : + 44 (0)1258 858171 FAX : + 44(0)1258 858170  
EMAIL: sales@lowenergydesigns.com Website: www.lowenergydesigns.com